

GENERAL NOTES:

36" HIGH SECTION (NO OPENINGS, 6" THK. WALL) = 8,450 LBS.
48" HIGH SECTION (NO OPENINGS, 6" THK. WALL) = 10,100 LBS.

OPENING SIZES AND LOCATIONS MAY VARY
(THIS INCLUDES RECTANGULAR
ACCESS DOORS AND CAST IN
RING AND COVERS)

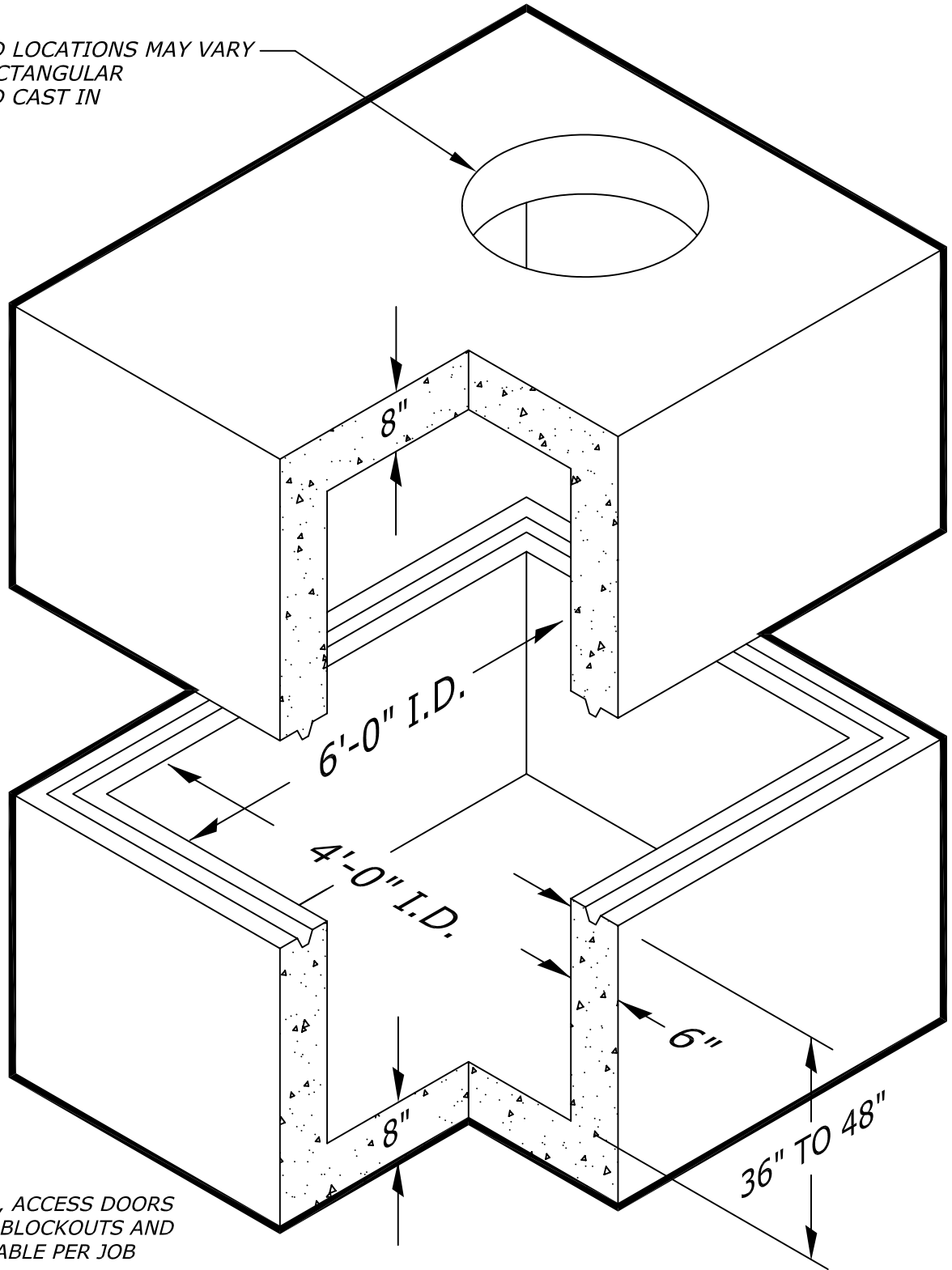

PULL IRONS, INSERTS, ACCESS DOORS
SUMPS, KNOCKOUTS, BLOCKOUTS AND
OPENINGS ARE AVAILABLE PER JOB
REQUIREMENTS.

